

$$x \rightarrow x + \bar{R}$$

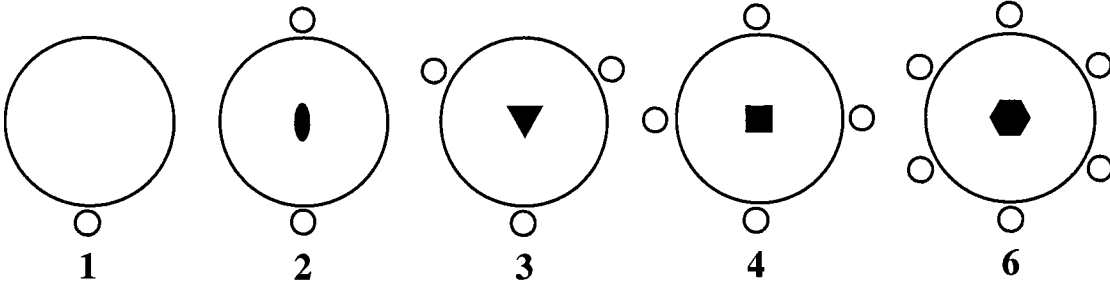

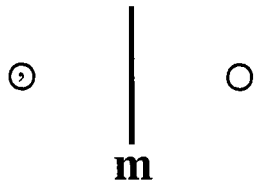

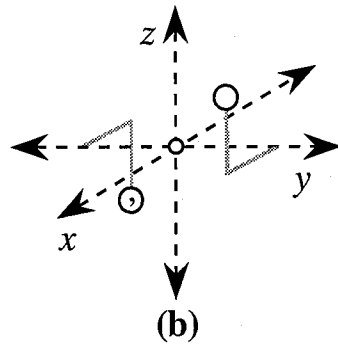

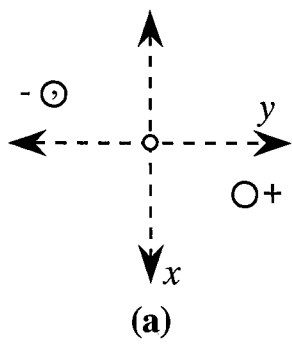
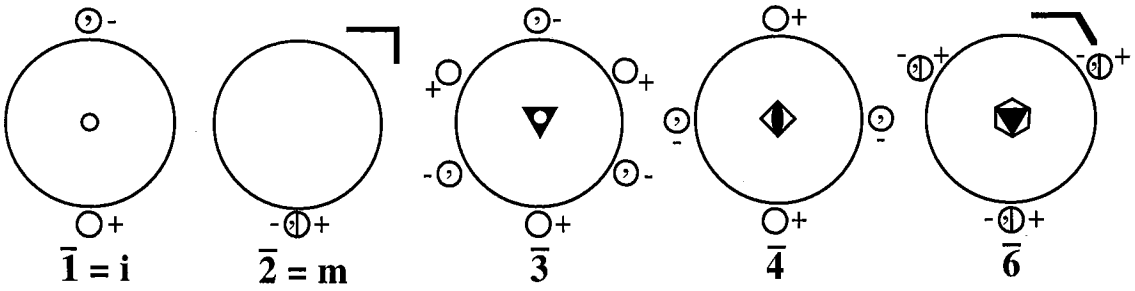

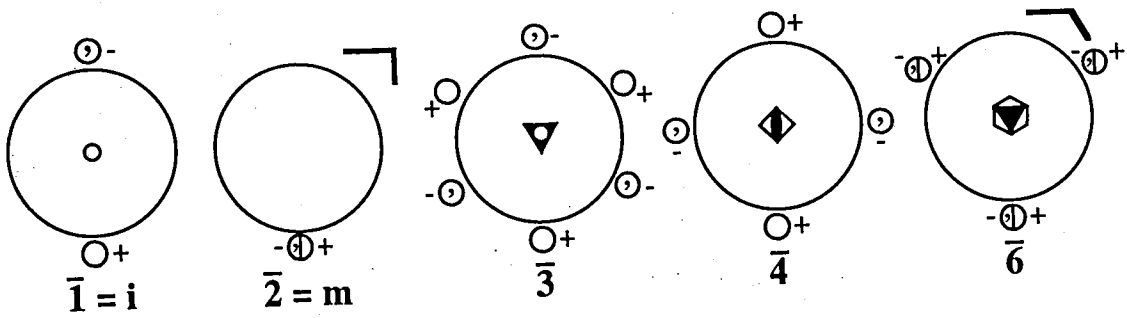
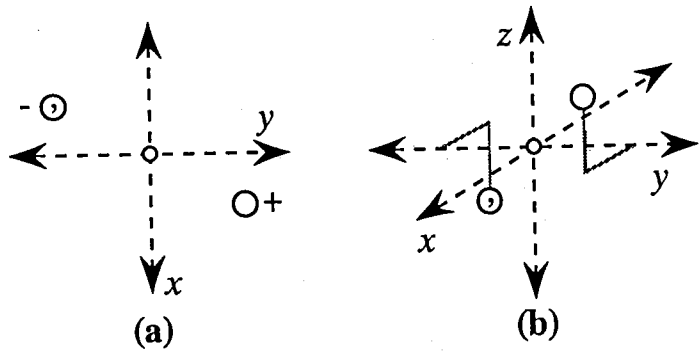
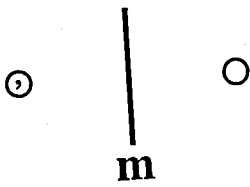
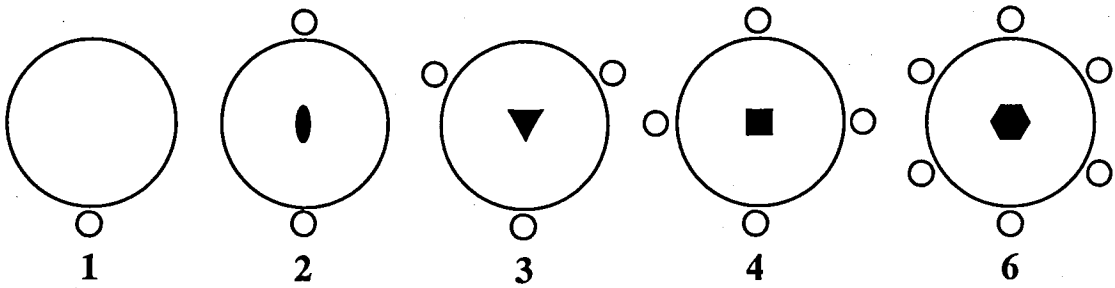

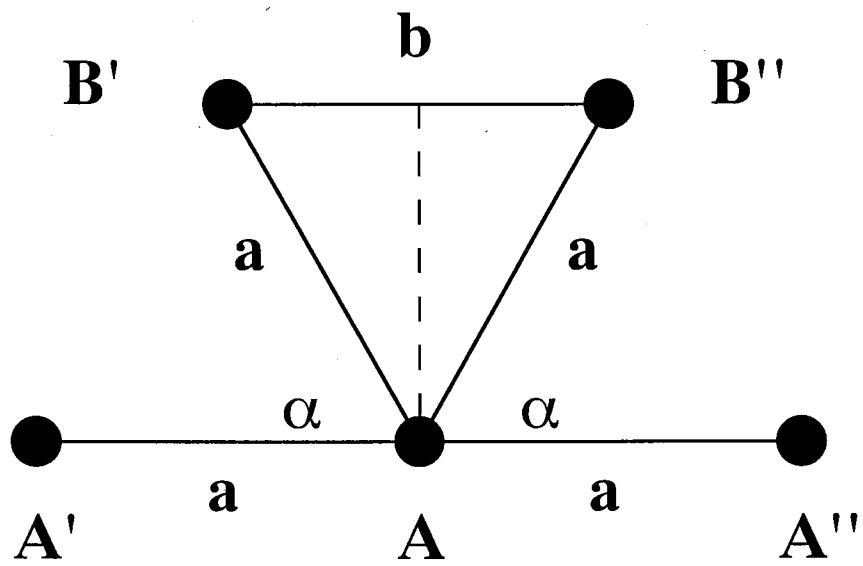

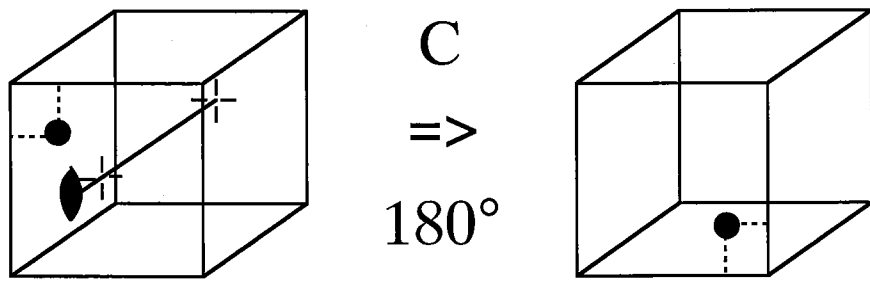
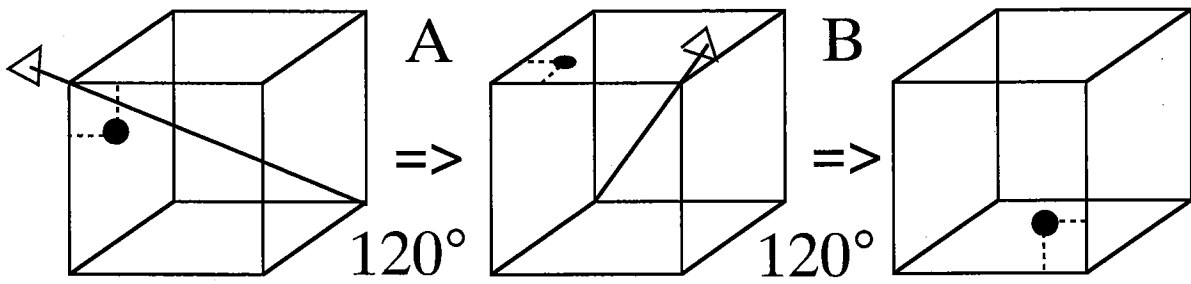



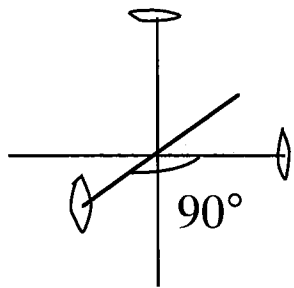

222

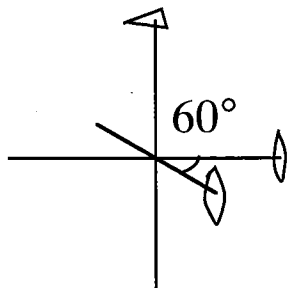

32

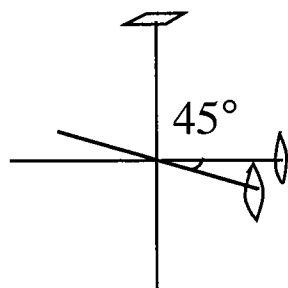

422

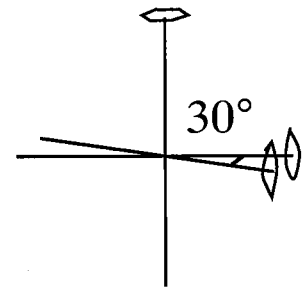

622

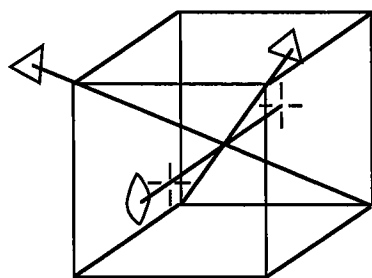

23

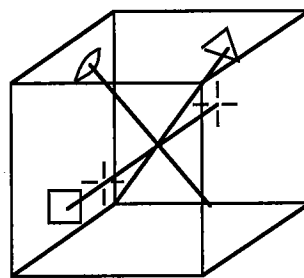

432

The crystallographic point groups and the lattice types .

crystal system	Schoenflies symbol	Hermann-Mauguin symbol	order of the group	Laue Group
Triclinic	$C_1$	1	1	$\bar{1}$
	$C_i$	$\bar{1}$	2	
Monoclinic	$C_2$	2	2	$2/m$
	$C_s$	m	2	
	$C_{2h}$	$2/m$	4	
Orthorhombic	$D_2$	222	4	mmm
	$C_{2v}$	mm2	4	
	$D_{2h}$	mmm	8	
Tetragonal	$C_4$	4	4	$4/m$
	$S_4$	$\bar{4}$	4	
	$C_{4h}$	$4/m$	8	
	$D_4$	422	8	$4/m$ mm
	$C_{4v}$	4mm	8	
	$D_{2d}$	$\bar{4}2m$	8	
	$D_{4h}$	$4/m$ mm	16	
Trigonal	$C_3$	3	3	$\bar{3}$
	$C_{3i}$	$\bar{3}$	6	
	$D_3$	32	6	$\bar{3}m$
	$C_{3v}$	3m	6	
	$D_{3d}$	$\bar{3}m$	12	
Hexagonal	$C_6$	6	6	$6/m$
	$C_{3h}$	$\bar{6}$	6	
	$C_{6h}$	$6/m$	12	
	$D_6$	622	12	$6/m$ mm
	$C_{6v}$	6mm	12	
	$D_{3h}$	$\bar{6}m2$	12	
	$D_{6h}$	$6/m$ mm	24	
Cubic	T	23	12	$m\bar{3}$
	$T_h$	$m\bar{3}$	24	
	O	432	24	$m\bar{3}m$
	$T_d$	$\bar{4}3m$	24	
	$O_h$	$m\bar{3}m$	48	

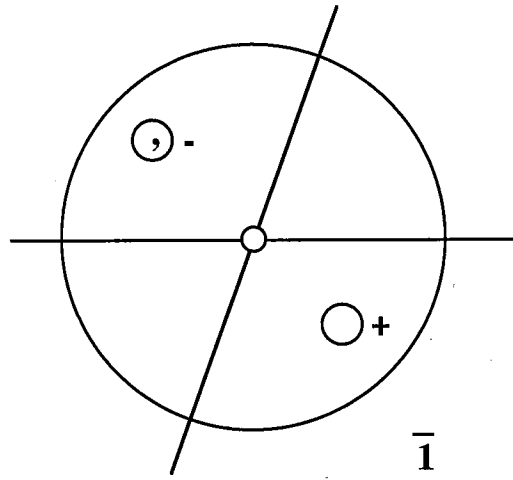
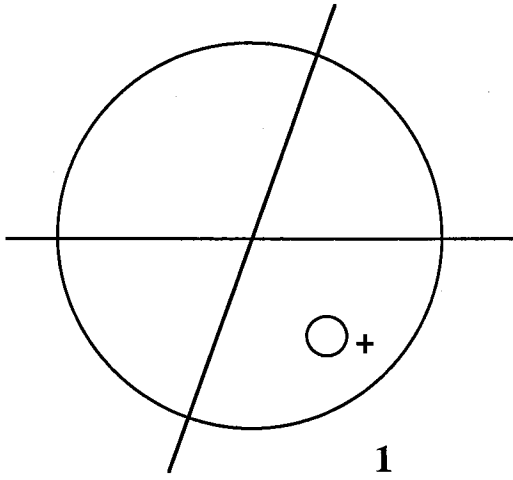

3.9.

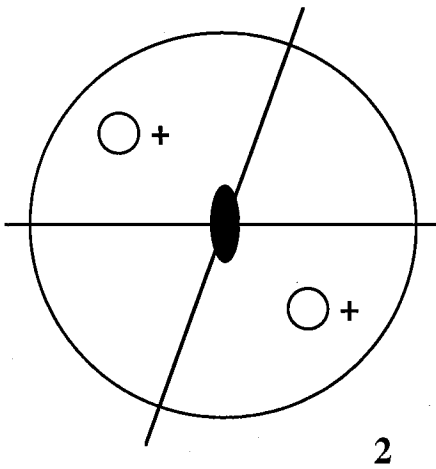

2

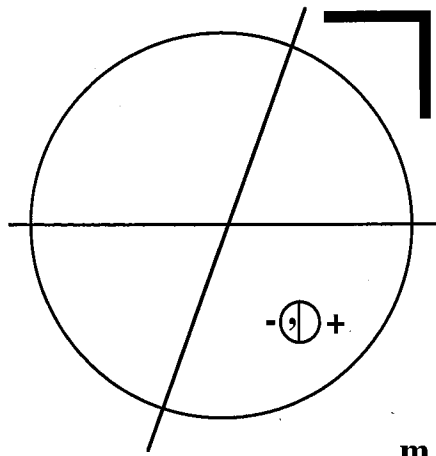

m

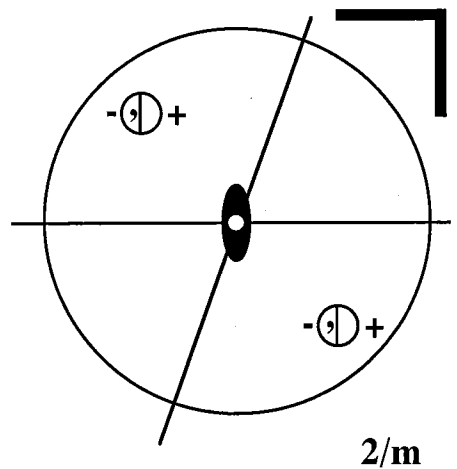

2/m

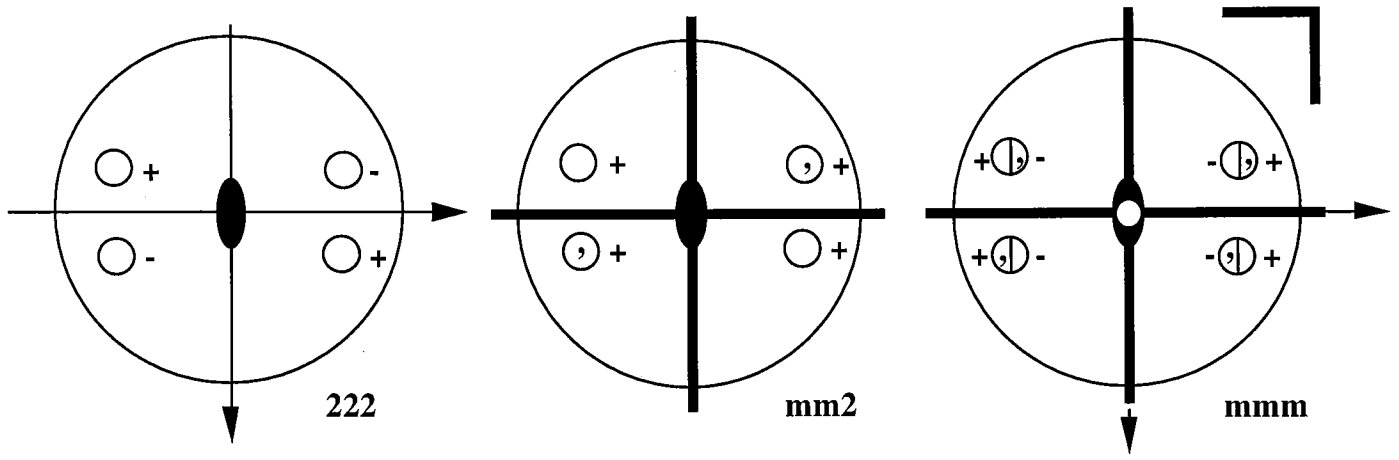

3.11

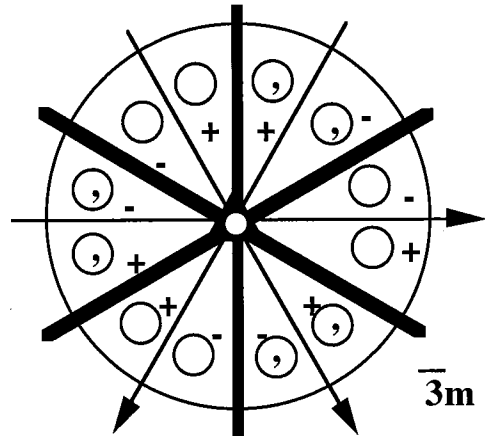
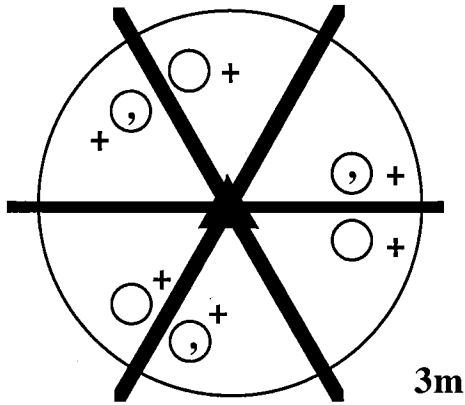
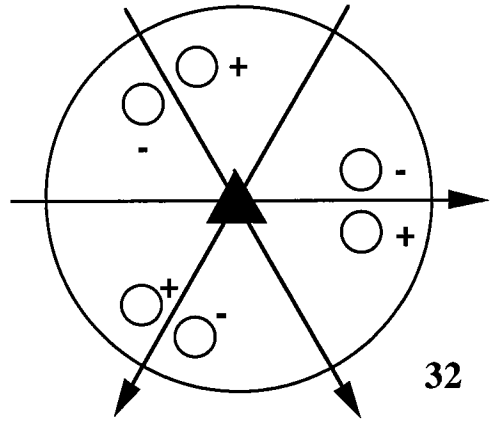
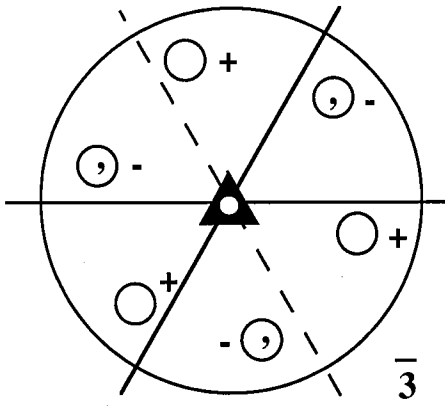
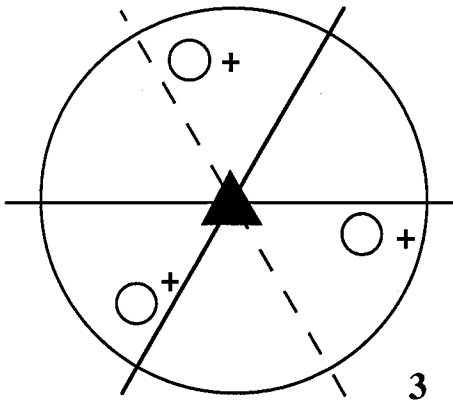

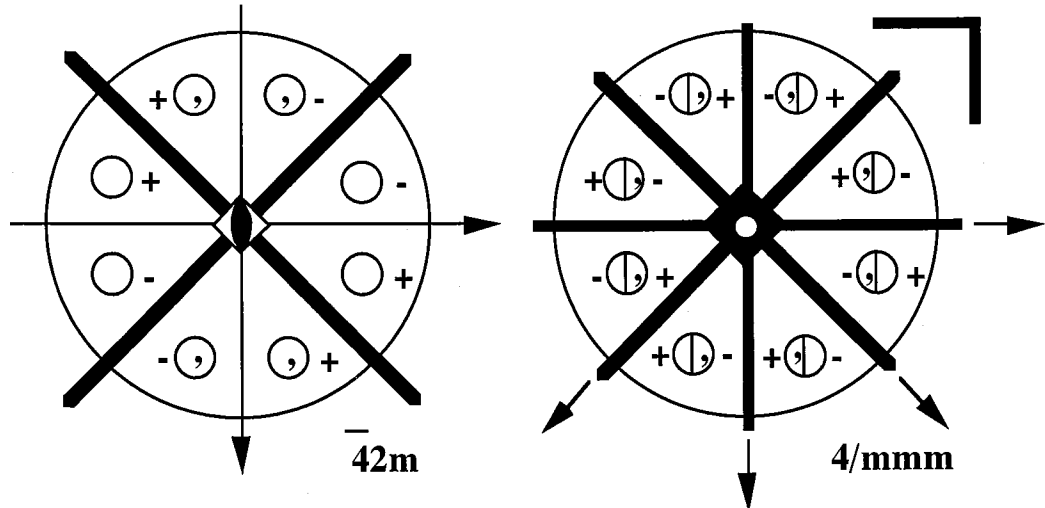
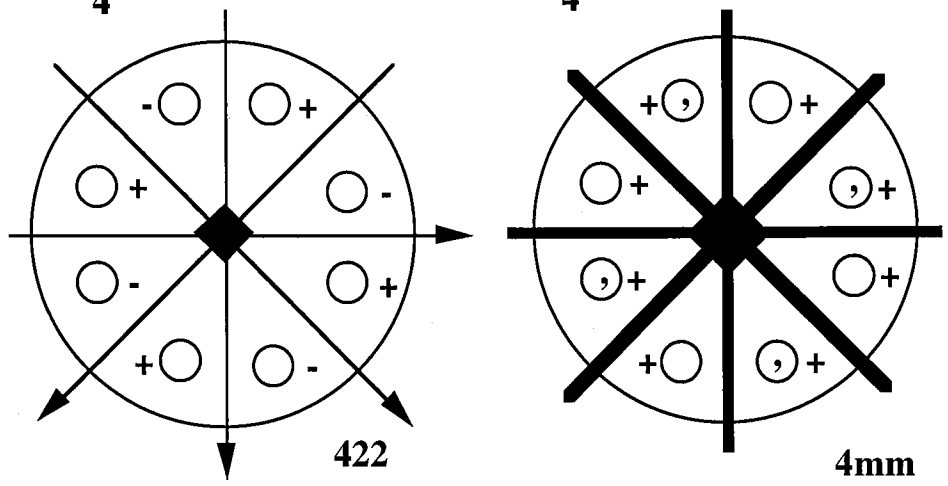
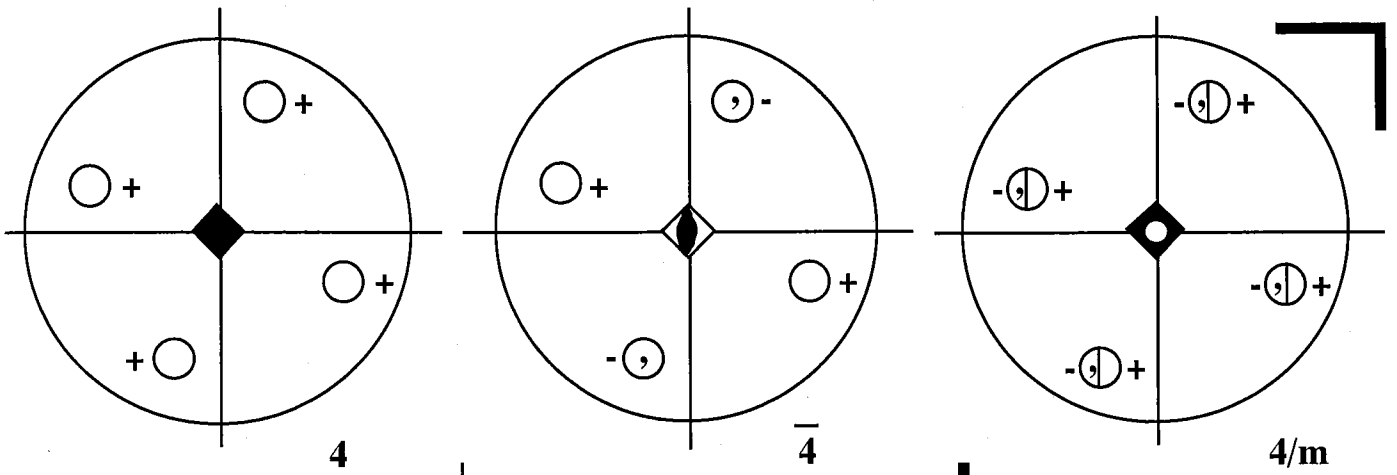

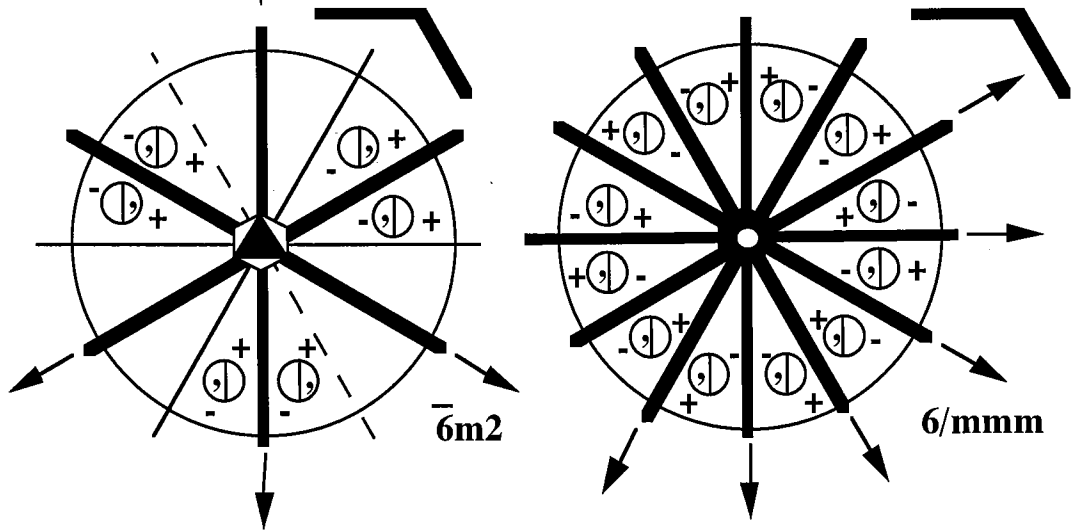
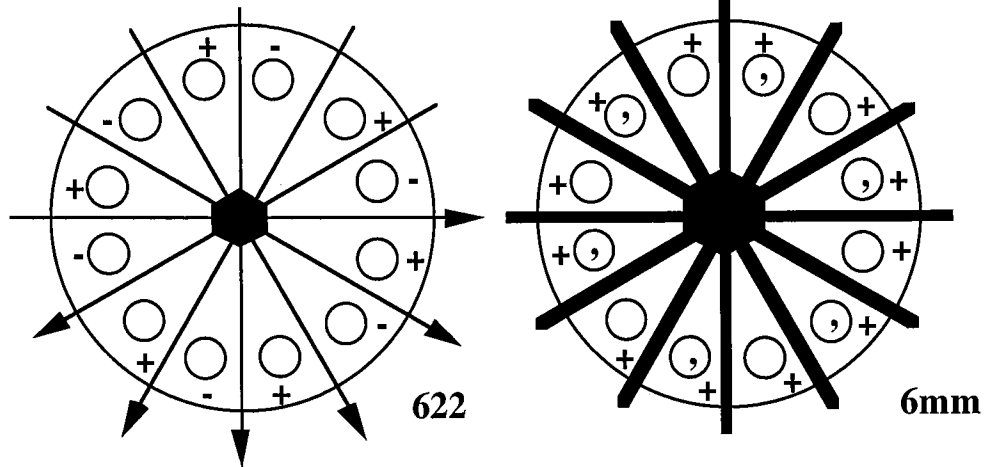
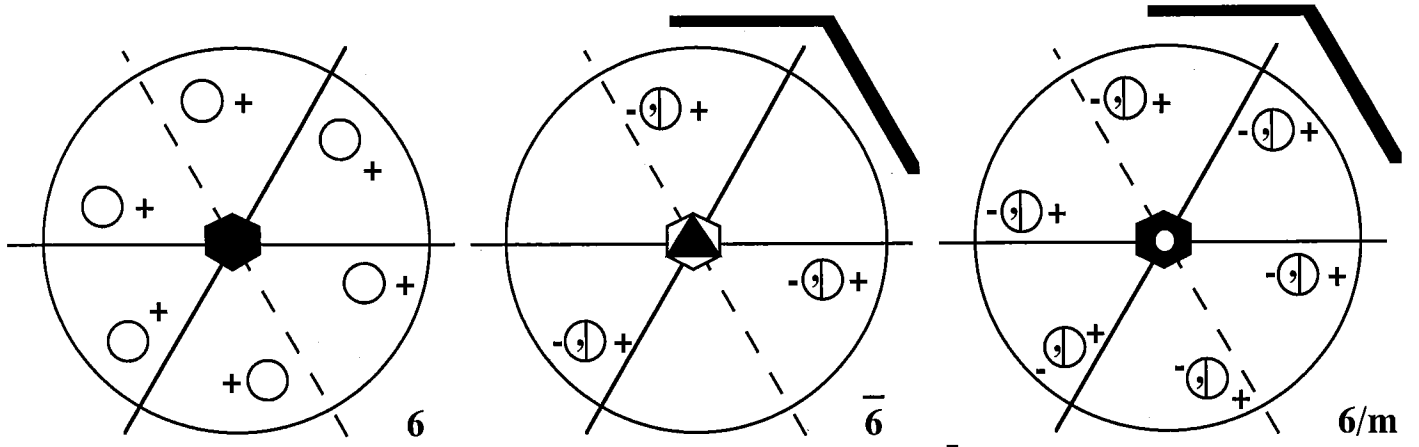



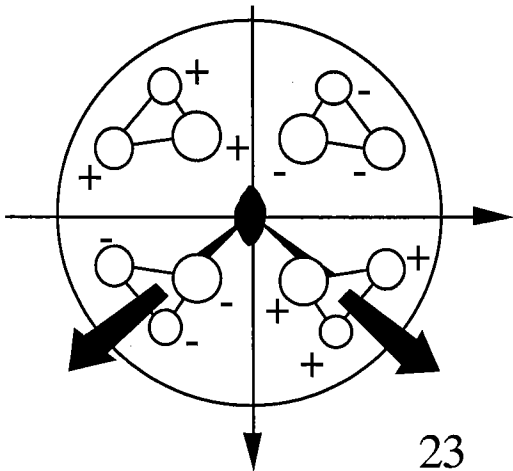
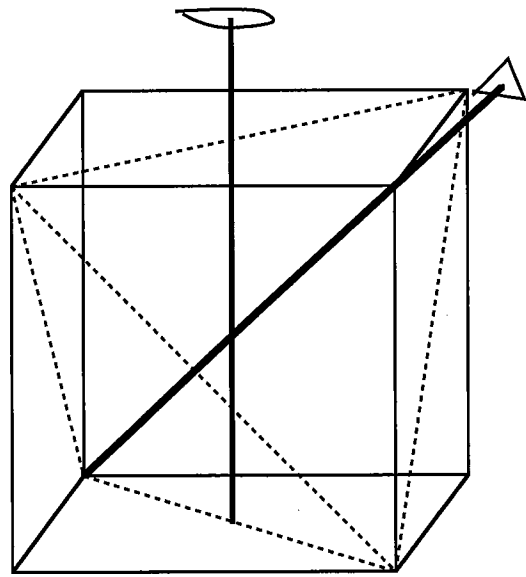
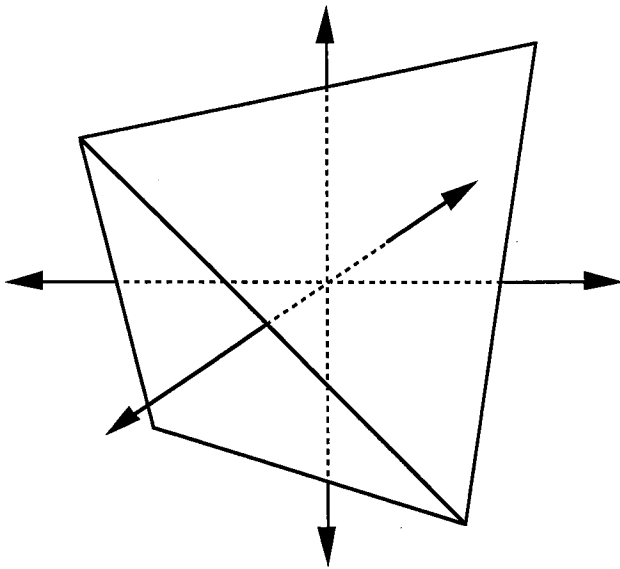

23

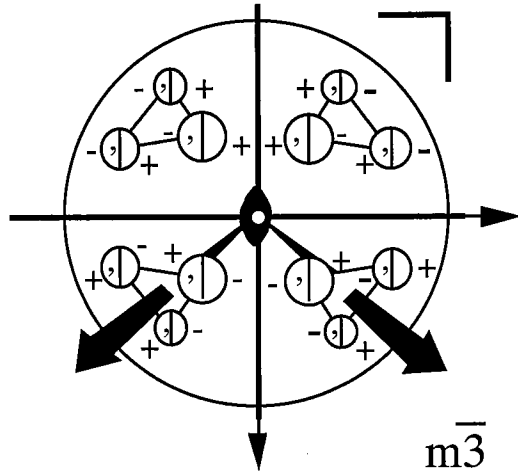

$\bar{m}3$

3.15

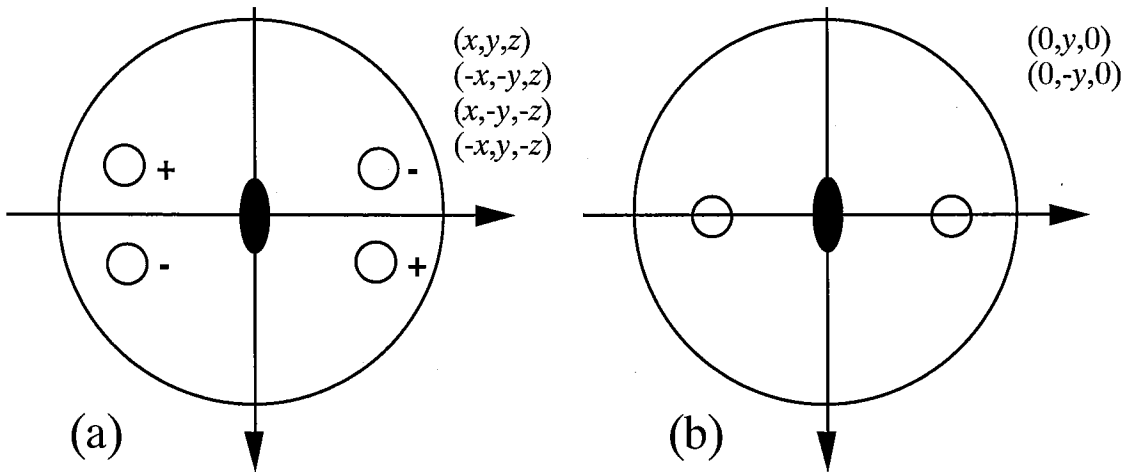

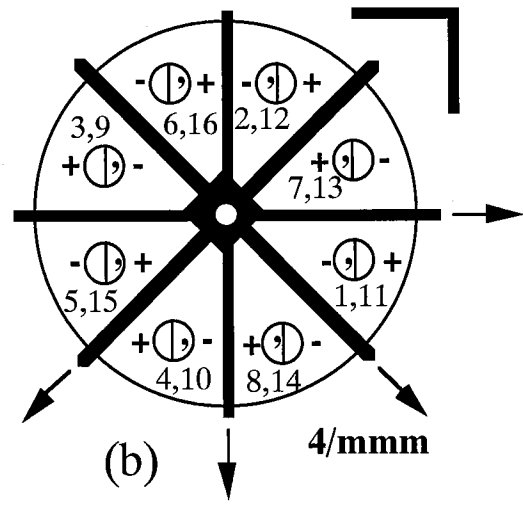
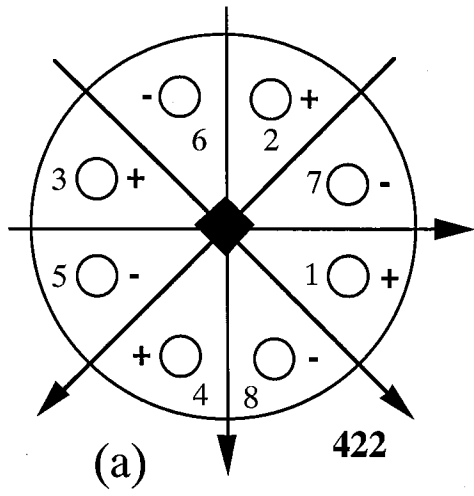



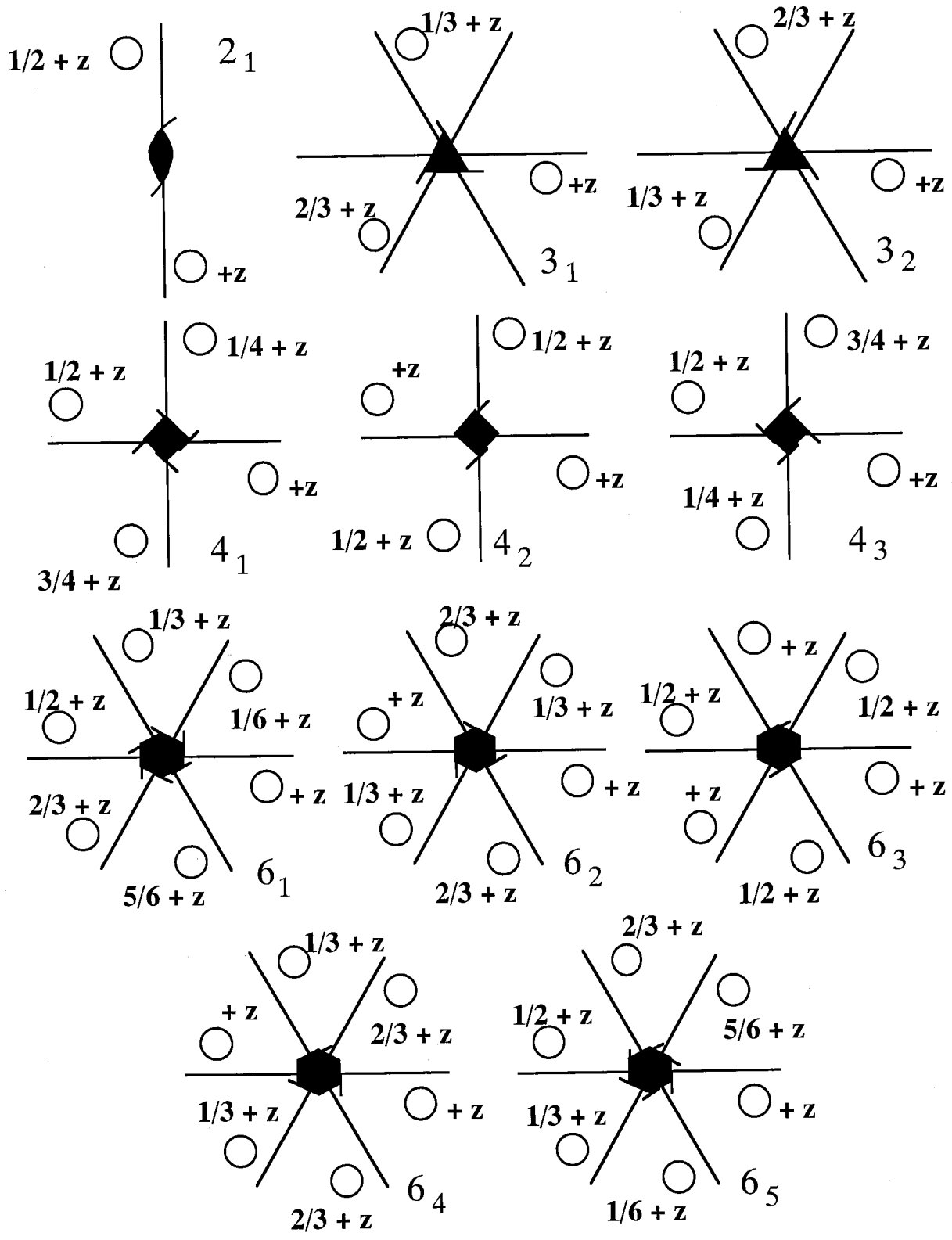

3.19

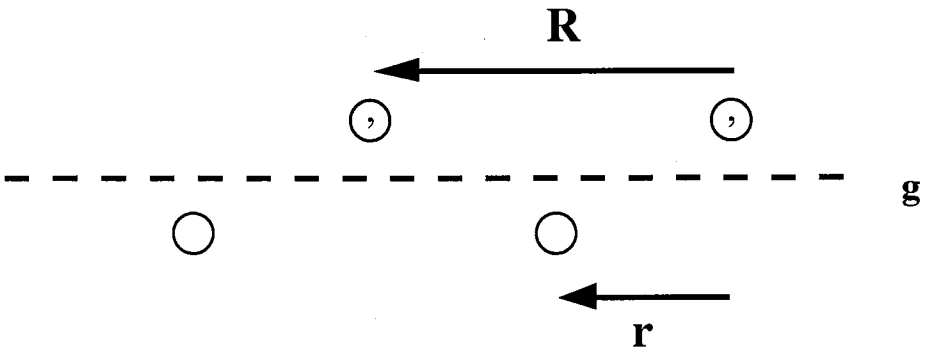

3-40

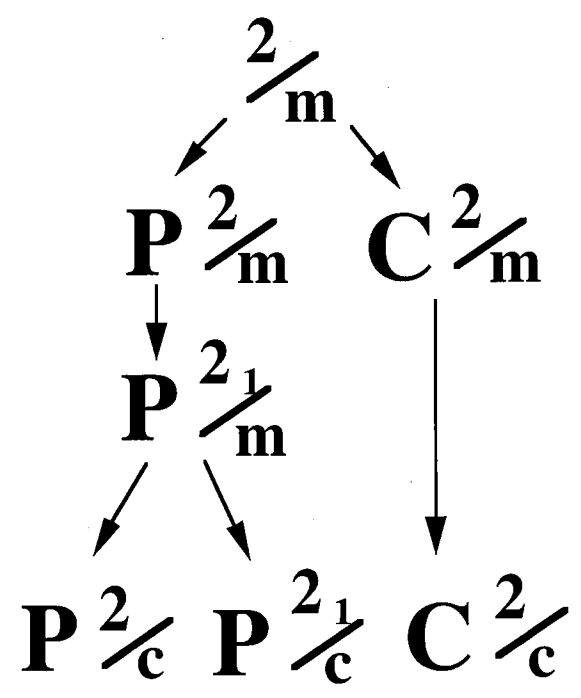
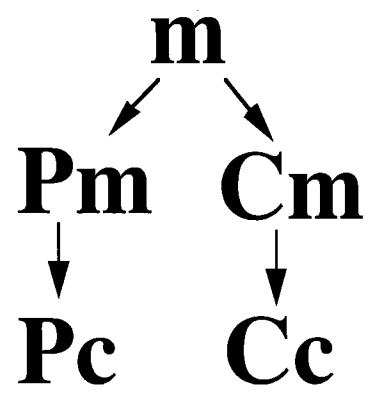
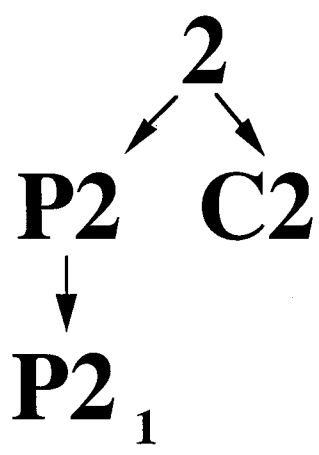

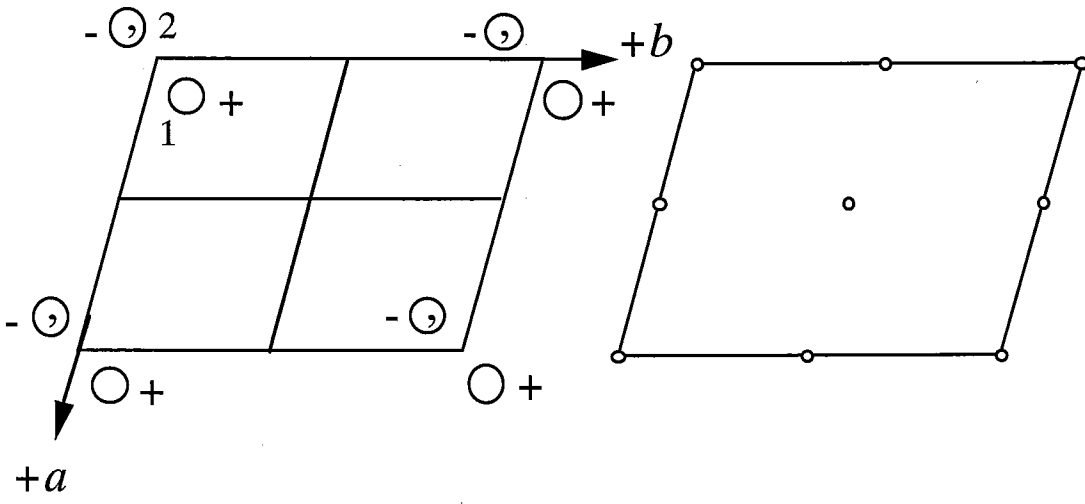



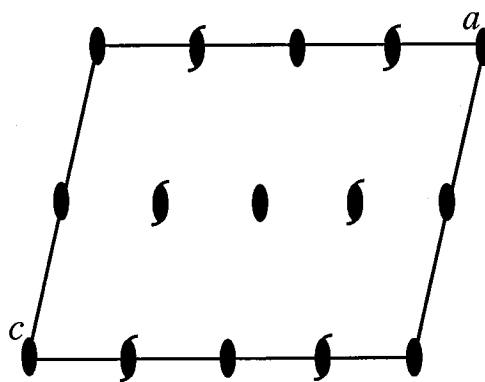
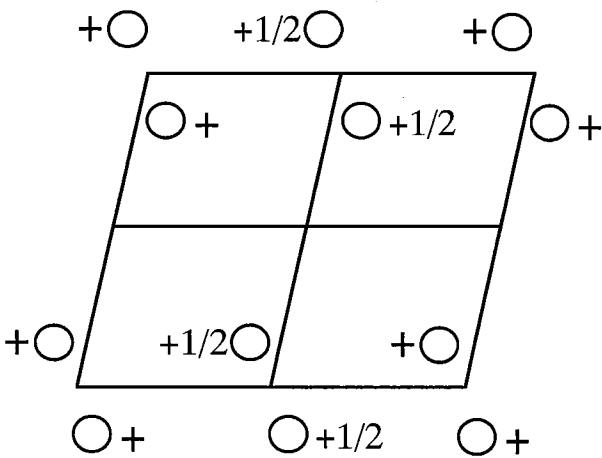
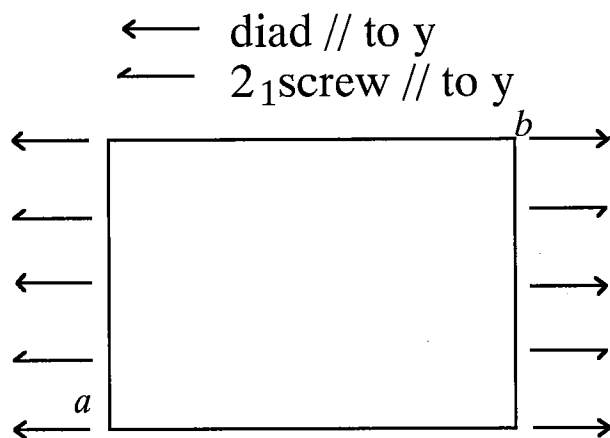
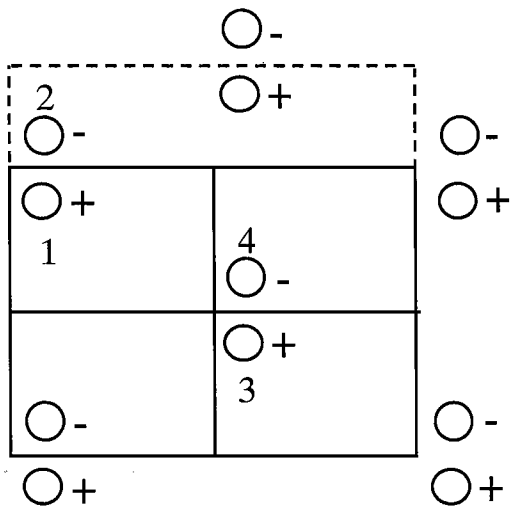

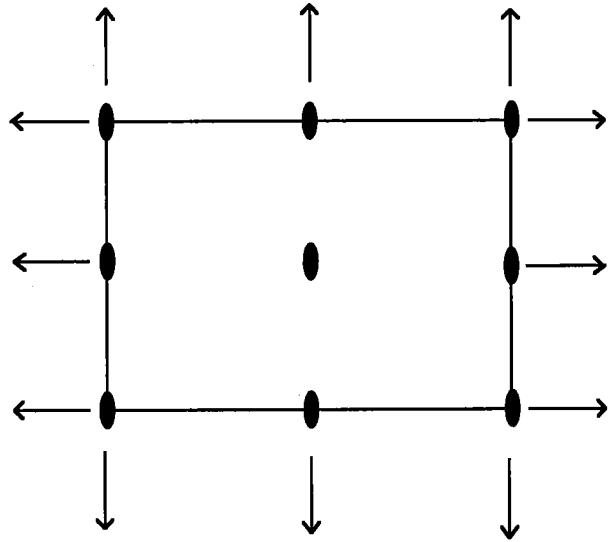
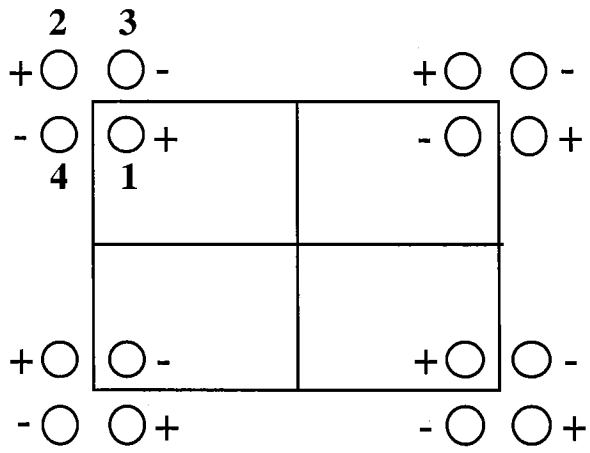

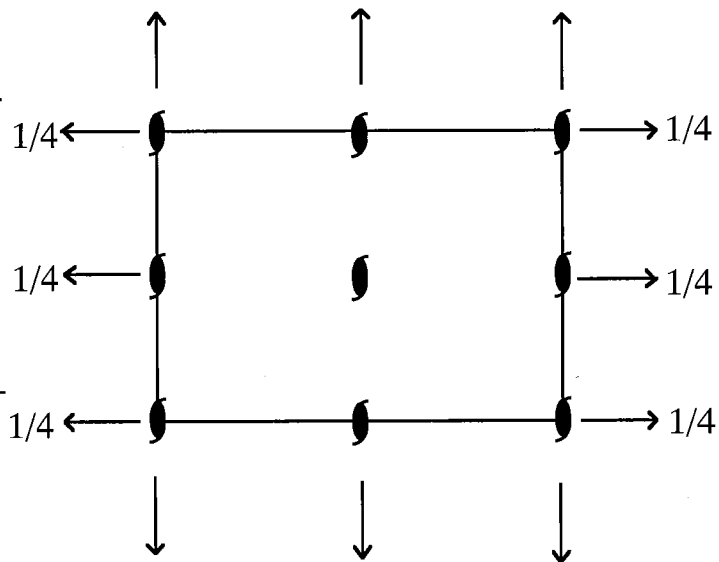
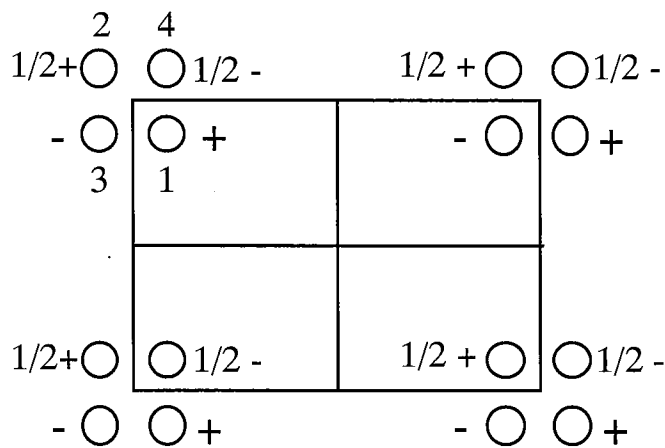

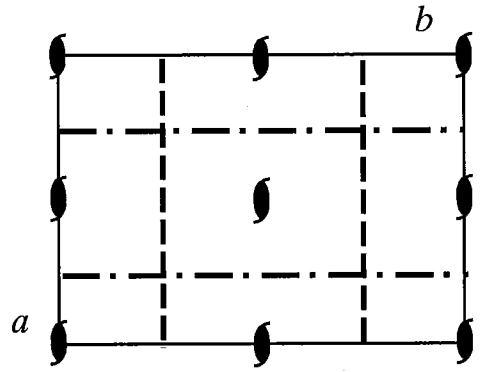
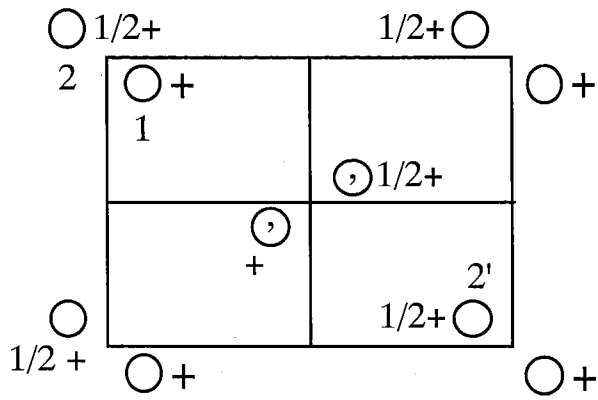

- - - - - axial glide plane  
 - . . . . diagonal glide plane

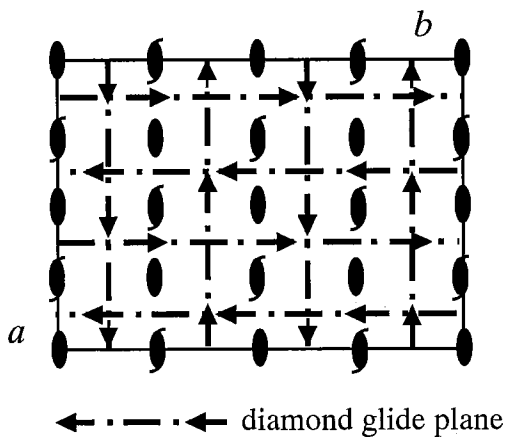
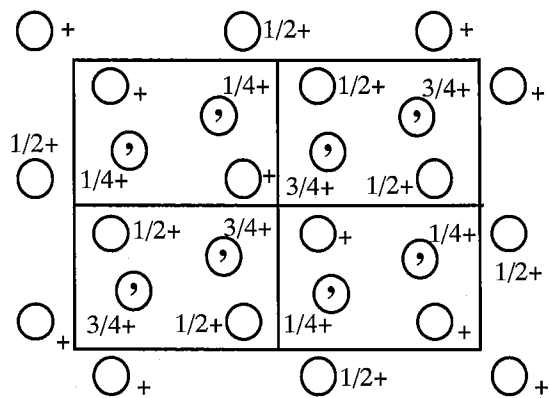

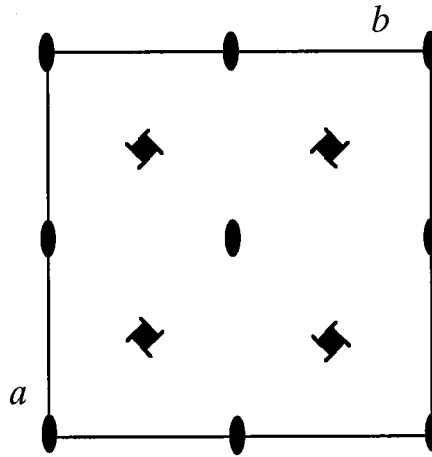
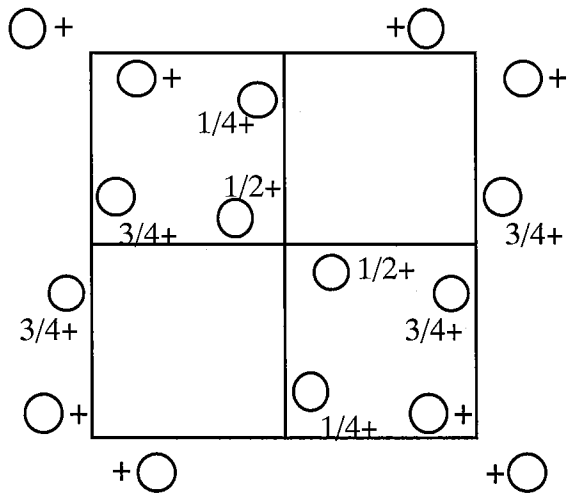

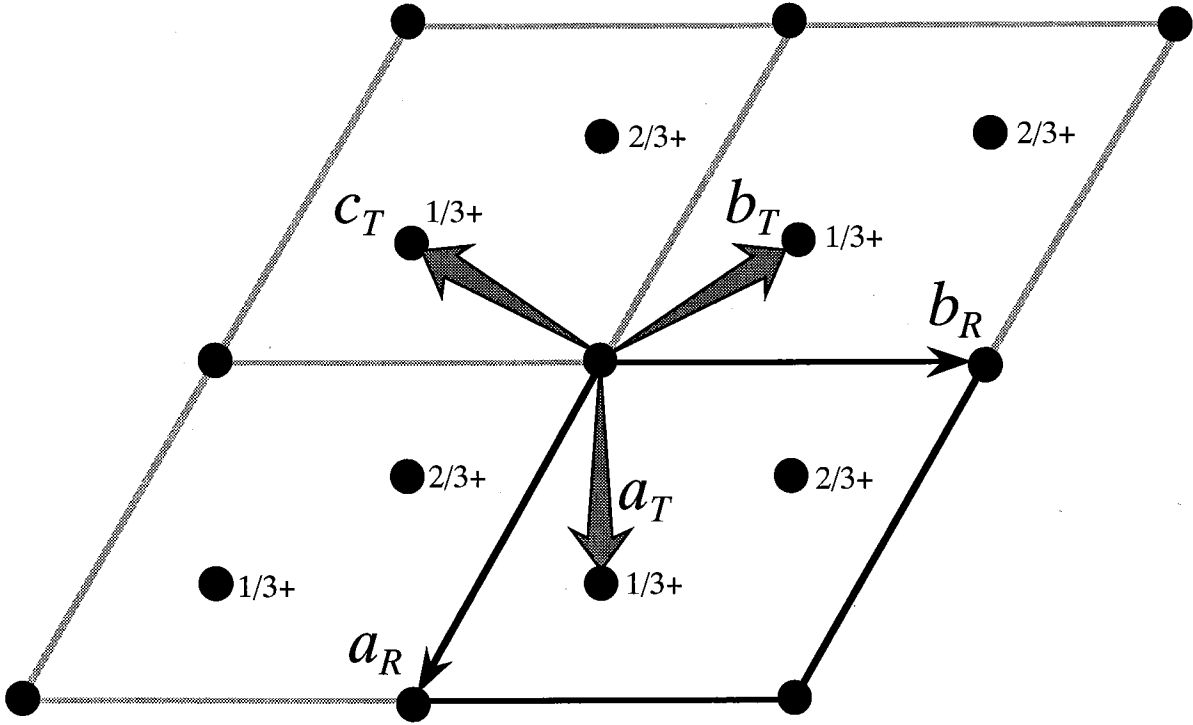

3.29

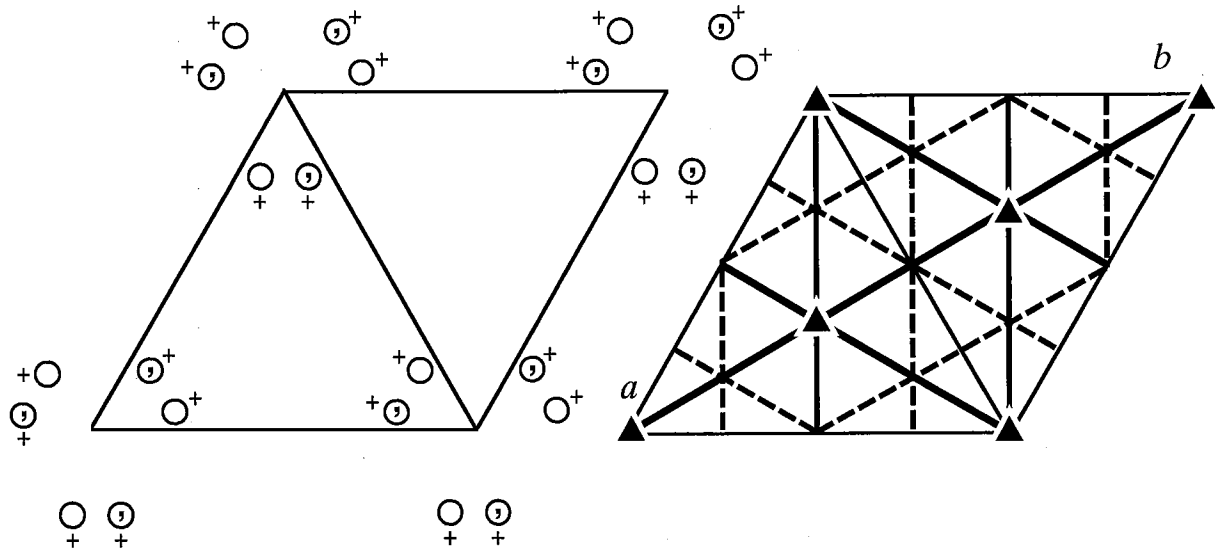

3.30



